

SCV-151H65

Variable Type Vacuum Capacitor (VH65 Type)

Specification

Peak test Voltage	15 kVp (at 50,60 Hz/ 1minute)
RF Working Voltage	9 kVp
Capacitance nominal	10 – 100 pF
Linear Variability	7.5±0.4 pF/Turn (C≥20 pF)
Maximum Current	54 Arms (13.56 MHz)
Tuner Turns	14±0.5 Turns
Tuner Operating Torque	0.18 Nm
Total Length	154 mm
Mounting Length	115 mm
Outer Diameter	φ 65 mm
Weight	1.2 kg



Drawing

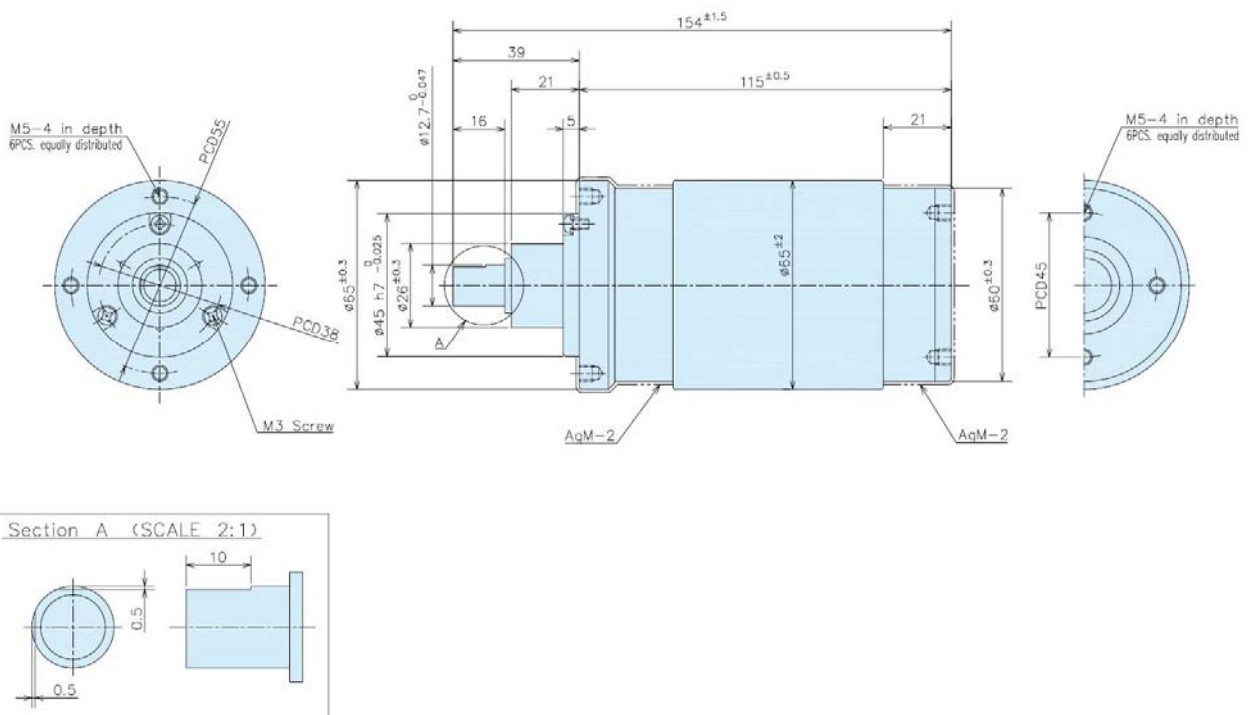

SCV-151H65

Variable Type Vacuum Capacitor (VH65 Type)

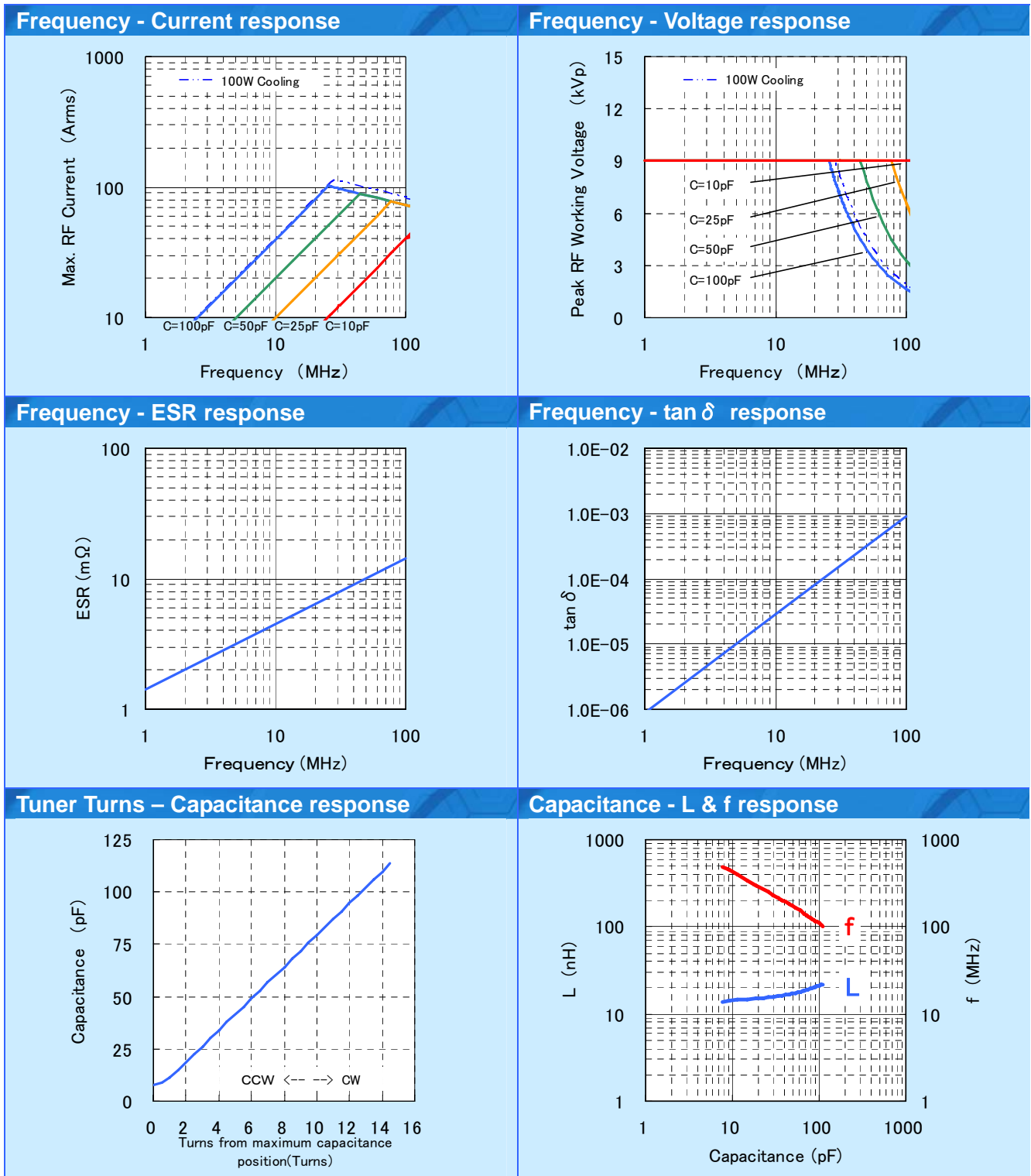

Notice: Current collecting system: Capacitor both-end full-face collection.

Cooling System: Conduction Cooling 50W.

Permissible surface temperature: 125°C.

(The surface temperature changes with current collecting conditions and ambient temperature.)

Ambient temperature: 25°C.

In regard to queries about these products, please contact below.

MEIDENSHA CORPORATION

Vacuum device Sales Department: ThinkPark Tower 2-1-1 Osaki, Shinagawa-ku, Tokyo, 141-6029 Japan

Phone: 81-3-6420-7590 Facsimile: 81-3-5745-3058 URL: <http://www.meidensha.co.jp>