

SCF-352.5H65C

Fixed Type Vacuum Capacitor(FH65 Type)

Specification

Peak Test Voltage	35 kVp (at 50,60 Hz/ 1 minute)
Working Voltage	21 kVp
Capacitance	250 pF
Maximum Current	155 Arms (at 13.56 MHz) 50 W (Conduction Cooling)
Total Length	87 mm
Outer Diameter	φ 65 mm
Mounting Length	87 mm
Weight	1.0 kg



Drawing

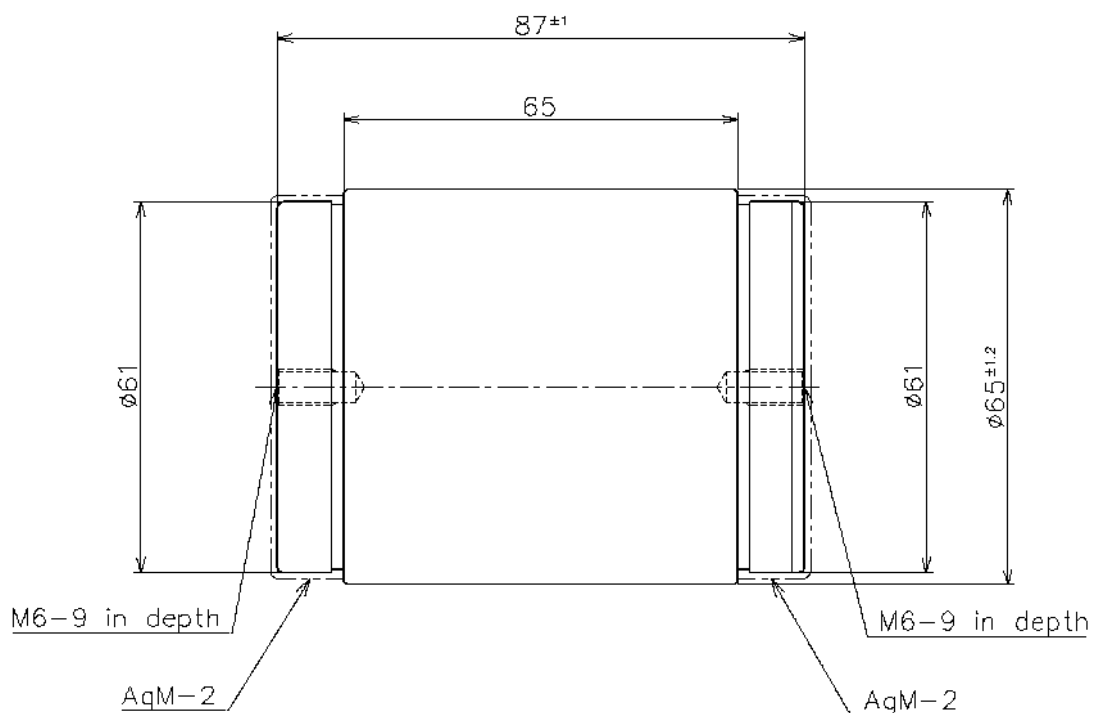

SCF-352.5H65C

Fixed Type Vacuum Capacitor(FH65 Type)

MEIDEN

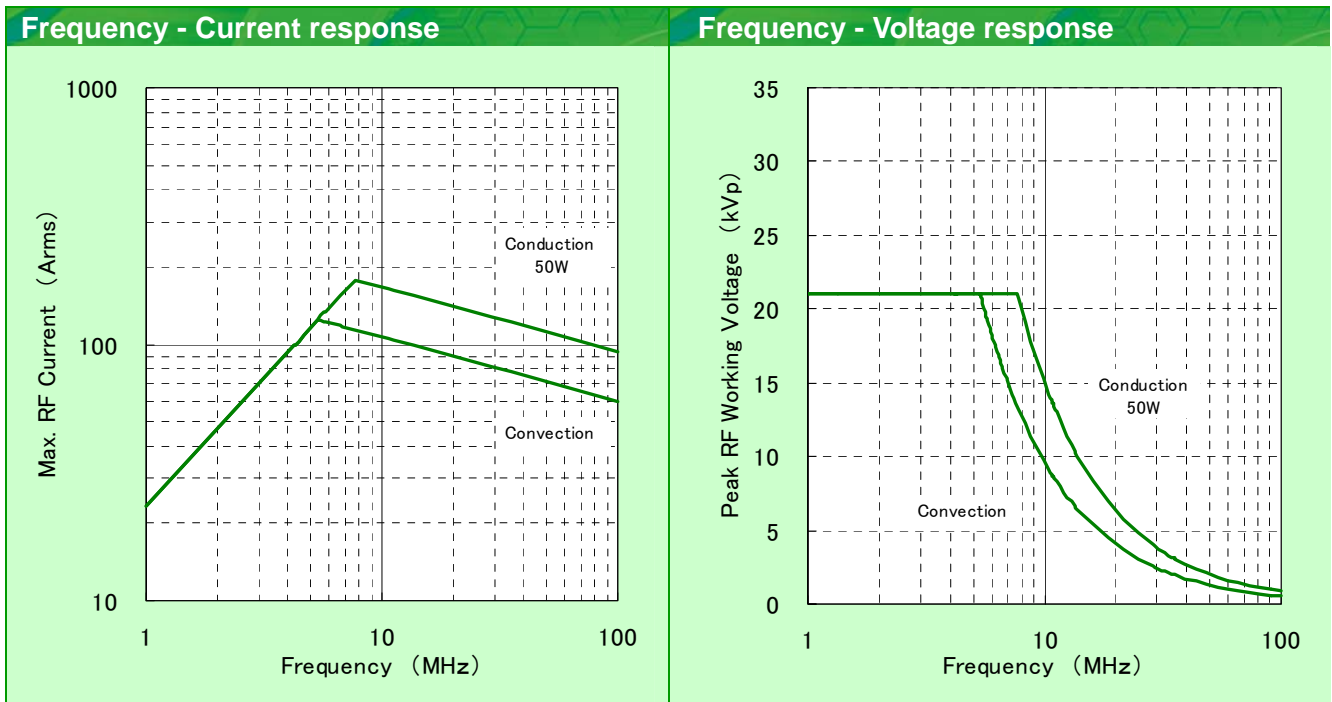

Notice:

- Current collecting system: Capacitor both-end full-face collection.
- Cooling System: Conduction Cooling 50W.
- Permissible surface temperature: 125°C.
(The surface temperature changes with current collecting conditions and ambient temperature.)
- Ambient temperature: 25°C.

In regard to queries about these products, please contact below.

MEIDENSHA CORPORATION

Vacuum device Sales Department: ThinkPark Tower 2-1-1 Osaki, Shinagawa-ku, Tokyo, 141-6029 Japan

Phone: 81-3-6420-7590 Facsimile: 81-3-5745-3058 URL: <http://www.meidensha.co.jp>

As of Apr.,2010