

SCF-200.3Z

Fixed Type Vacuum Capacitor(FS36 Type)

Specification

Peak Test Voltage	20kV,peak (at 50,60 Hz/ 1 minute)
RF Working Voltage	12 kV,peak (at 13.56 MHz)
Capacitance	30 pF
Maximum Current	27 A,rms (at 13.56 MHz)
Total Length	43 mm
Outer Diameter	φ36 mm
Mounting Length	43 mm
Weight	0.13 kg



Drawing

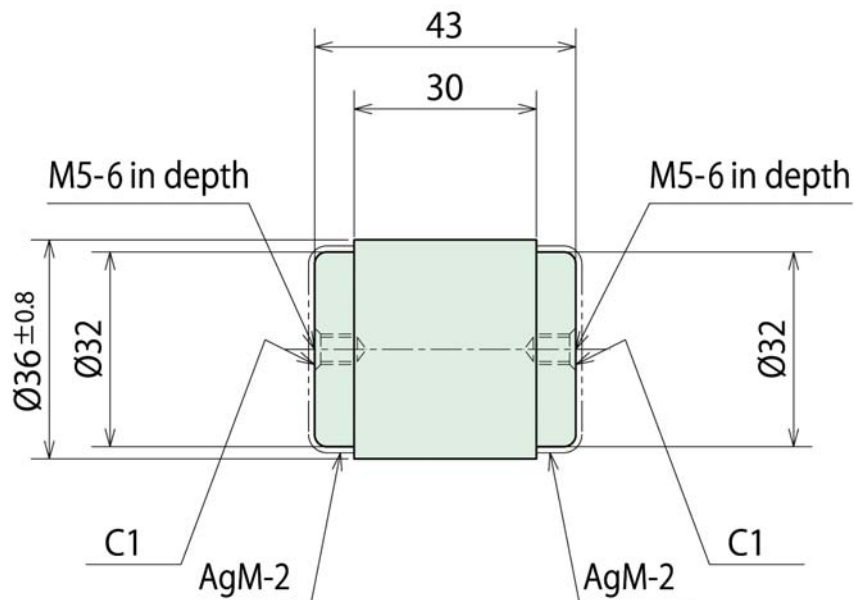

SCF-200.3Z

Fixed Type Vacuum Capacitor(FS36 Type)

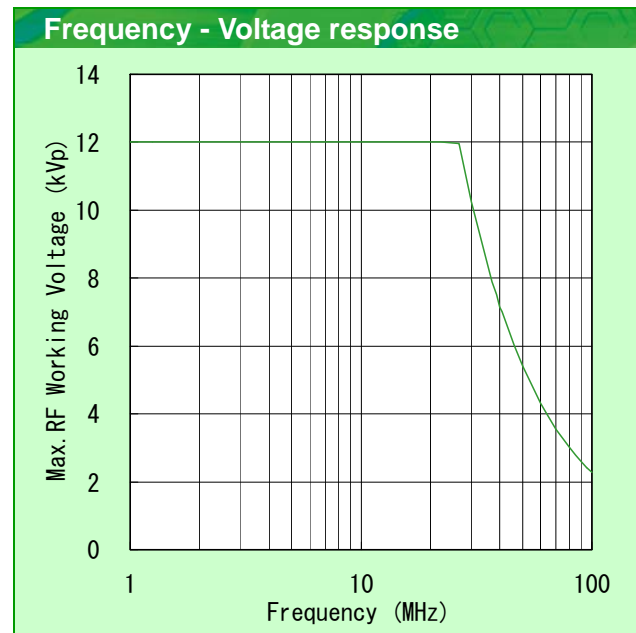
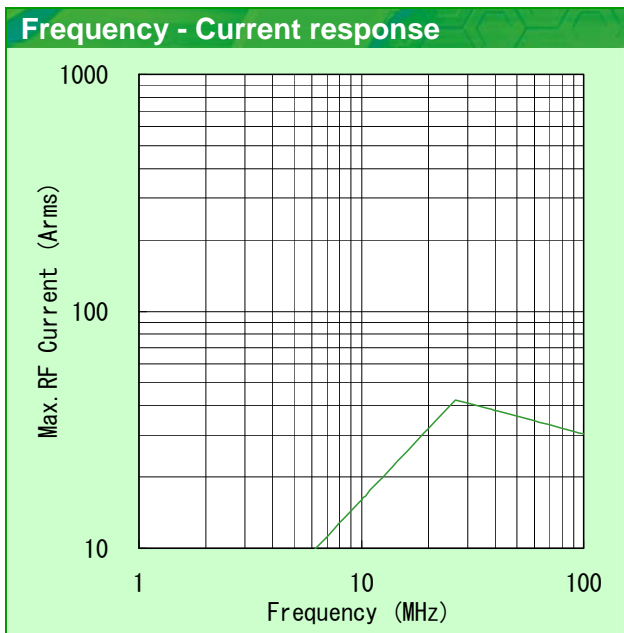

Notice:

- Current collecting system: Capacitor both-end full-face collection.
- Cooling System: Convection.
- Permissible surface temperature: 125°C.
(The surface temperature changes with current collecting conditions and ambient temperature.)
- Ambient temperature: 25°C.

MEIDENSHA CORPORATION

ThinkPark Tower 2-1-1 Oosaki, Shinagawa-ku, Tokyo, 141-6029 Japan

Phone: 81-3-6420-7510 Facsimile: 81-3-5745-3053 URL: www.meidensha.co.jp